



nu[®]
Simply Better

*UniSee*TM Installation Guide

Vehicle Multi Camera System

Catalog of Unisee 300/400 Installation Guide:

1. Caution	1
2. Package.....	2
3. Classified of Unisee 300/400.....	3
4. System Control Box.....	5
5. Definitions of Harness	6
6. Mode Selection and Operation.....	7
7. Install the Cameras.....	11
8. Install the Harness.....	14
9. System Functions.....	18
10. Troubleshooting.....	19
11. Specification.....	20

Caution

●Power

The product accepts 9V to 30V DC that could adopt the vehicle with 12V or 24V. The 12V output of control box is for 4 cameras and 1 LCD monitor only, please do not connect other device.

●Safety

The control box is in-car use only. To prevent the risk of short circuit or electric shock, do not use in a moist environment. If any liquid or solid object gets into the box, please turn off the power immediately and ask help from professional. If error occurred, please contact professional technician or the local distributor. Please do not repair it by yourself.

●Control Box Install Position

The recommended install position is under the driver's seat or dashboard. If you have to install on other position, please avoid the places where near the heat, under the sun, around with dust, humidity, strong magnetic fields, or vibration and shock.

●Copyright

Monitor the image from the cameras; please do not infringe a third party related right. It's possible to damage the product if you modify the product without the confirmation from our company or authorized units.

●System Function

Low power consumption; support four signals inputs (Left, Right, Backup, SW); Over voltage protection; Reversed power protection.

Package

- Please open the package and check the below items are inside.

		
Control Box	Switch	Camera 3 or 4 PCS (Remark)
		
Harness	Manual	Accessory Box

- After checking, please follow the instruction to install. (Remark)Camera quantity depends on the model

Classified of Unisee 300/400:

- Please open the package and check the below items are inside.

Unisee 300 A

Front Side Collision Prevention Camera System
+ Rear view camera system



Item	Page
Control box & Harness Definition	Page.5~6
Mode Selection	Page .7
Rear Camera(CH1)	Page.11
Front Cameras(CH2 &3)	Page.12

Unisee 300 B

Blind Spot Assist System
+ Rear view camera system

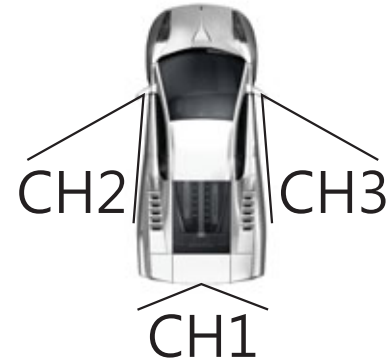

Item	Page
Control box & Harness Definition	Page.5~6
Mode Selection	Page .8
Rear Camera(CH1)	Page.11
Front Cameras(CH2 &3)	Page.13

Unisee 400A

Front Side Collision Prevention Camera System
+ One Blind Spot Assist System
+ Rear view camera system

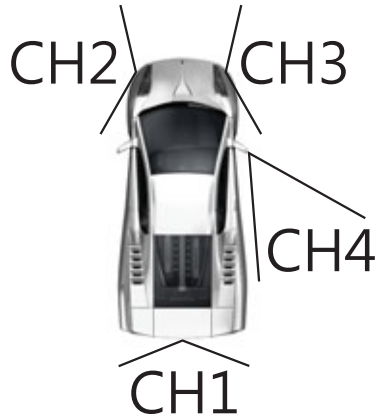

Item	Page
Control box & Harness Definition	Page.5~6
Mode Selection	Page .9
Rear Camera(CH1)	Page.11
Front Cameras(CH2 &3)	Page.12
Right Side Camera(CH4)	Page.13

Unisee 400 B

Front Side Collision Prevention Camera System
+ Blind Spot Assist System

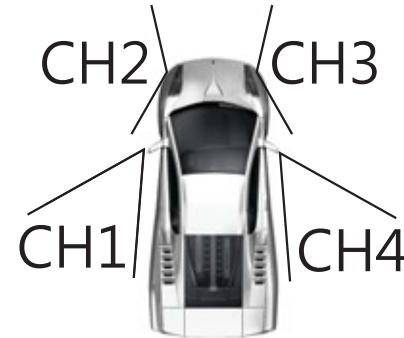

Item	Page
Control box & Harness Definition	Page.5~6
Mode Selection	Page.10
Rear Camera(CH2 &3)	Page.12
Front Cameras(CH1 &4)	Page.13

System Control Box

- The definitions of control box are as below:

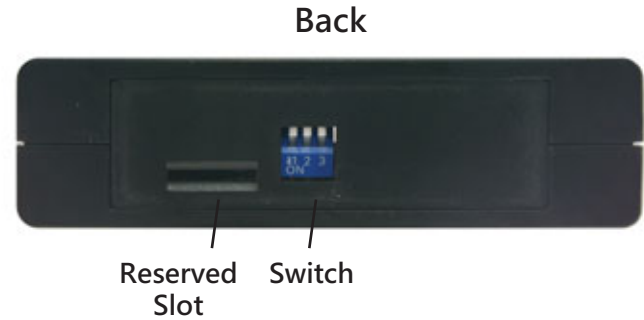
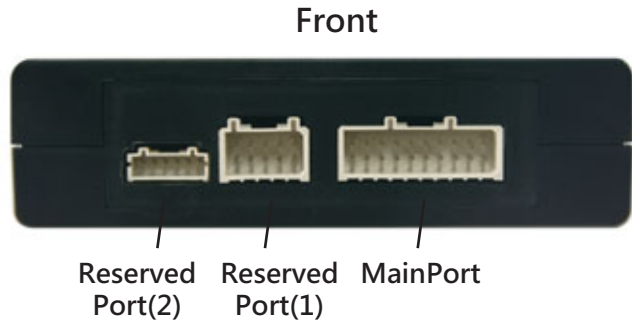

Definitions of Harness

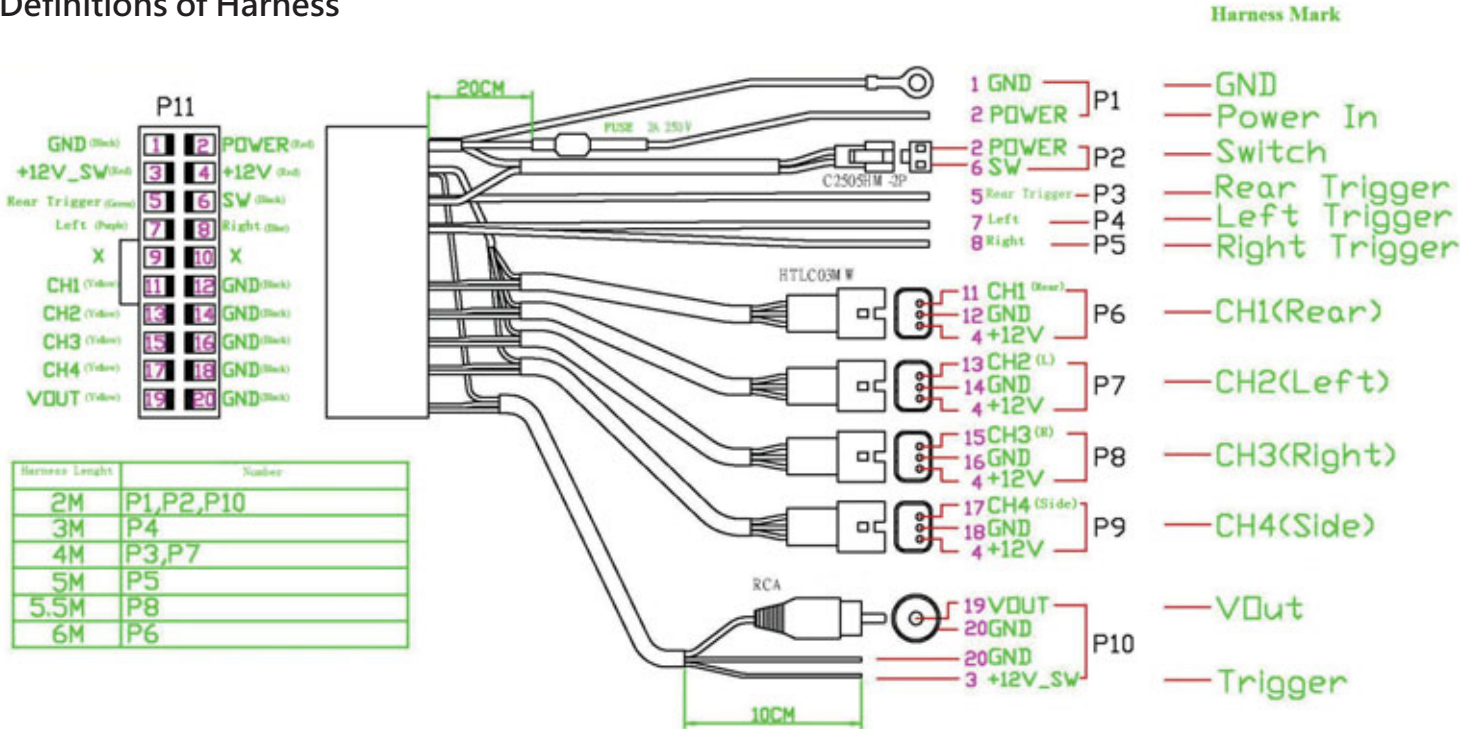







Power on

Check all the harness is connected correctly before connect with the control box and the power supply system of vehicle.





● **Mode Selection**

Please follow the below classified and adjust the switch at the back of the control box to choose the mode.
If there is any change of mode selection, please turn off the engine and re-start it to reset the control box.



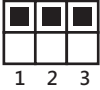
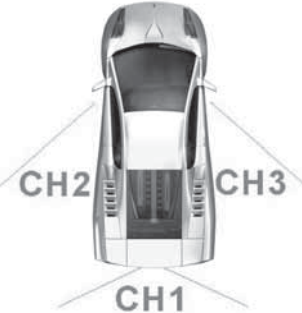

● **Unisee 300A:**

<p>Switch adjustment:</p>  <p>1 2 3</p>	<p>Operation:</p>	
<p>Camera positions:</p> 	<p>Reverse trigger: (Shows the rear view with assist line when shift into reverse gear) +12V output+ monitor shows CH1</p>  <p>(Mirror)</p> <p>SW trigger: Press the switch button and the monitor shows the left and right view with separate screen. 12V output. After 1 min, it turns off automatically. (or press it again to turn it off)</p> 	<p>Left trigger: The vehicle shows the left view from CH2 when turning left.</p>  <p>Right trigger: The vehicle shows the right view from CH3 when turning right.</p> 



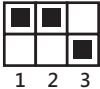

● Unisee 300B:

<p>Switch adjustment:</p> 	<p>Operation:</p>	
<p>Camera positions:</p> 	<p>Reverse trigger: (Shows the rear view with assist line when shift into reverse gear) +12V output+ monitor shows CH1</p>  <p>(Mirror)</p> <p>SW trigger: Press the switch button and the monitor shows the left and right view with separate screen. 12V output. After 1 min, it turns off automatically. (or press it again to turn it off)</p> 	<p>Left trigger: The vehicle shows the left view from CH2 when turning left.</p>  <p>(Mirror)</p> <p>Right trigger: The vehicle shows the right view from CH3 when turning right.</p>  <p>(Mirror)</p>

● Unisee 400A :

<p>Switch adjustment:</p>  <p>1 2 3</p>	<p>Operation:</p>	
<p>Camera positions:</p> 	<p>Reverse trigger: (Shows the rear view with assist line when shift into reverse gear) +12V output+ monitor shows CH1</p>  <p>(Mirror)</p> <p>SW trigger: Press the switch button and the monitor shows the left and right view with separate screen. 12V output. After 1 min, it turns off automatically. (or press it again to turn it off)</p> 	<p>Left trigger:</p> <p style="text-align: center; font-size: 2em;">No action</p> <p>Right trigger: The vehicle shows the right view from CH3 when turning right.</p>  <p>(Mirror)</p>

● Unisee 400B :

<p>Switch adjustment:</p>  <p>1 2 3</p>	<p>Operation:</p>	
<p>Camera positions:</p> 	<p>Reverse trigger:</p> <p style="text-align: center; font-size: 2em;">No action</p> <p>SW trigger: Press the switch button and the monitor shows the left and right view with separate screen. 12V output. After 1 min, it turns off automatically. (or press it again to turn it off)</p> 	<p>Left trigger: The vehicle shows the left view from CH2 when turning left.</p>  <p>(Mirror)</p> <p>Right trigger: The vehicle shows the right view from CH3 when turning right.</p>  <p>(Mirror)</p>

Install the Cameras :

1.Backup Image:

- Please install camera C1318N. You could choose to install on the center of rear bumper or the top of plate.
 - ※ The camera builds within the parking guide line which bases on the 60cm height and 183cm width. Please be noticed the parking guide line would “NOT” adjust automatically by different height or width of vehicles.
- Drill a camera mounting hole with $\varnothing 20\text{mm}$ on the center of rear bumper. Assemble camera and harness temporarily until the all system install completely. Fix the camera after confirm the image and signal source are correct in last step. Please keep camera toward upside with triangle sign. (The triangle is on the side and back of camera)



2 Install on the top of plate.

Camera needs assembly with cover housing and mount on the top of plate. Near central part will be the better place.

Cover Housing for
backup image



2. Front Image :

Please install camera C0618N. You could choose to install on the center of rear bumper or the top of plate.

2.1 The best install position of front bumper : the forefront point of vertical line as below photo.



2.2 Drill a camera mounting hole with $\varnothing 20\text{mm}$ on the left and right corner of front bumper. Assemble camera and harness temporarily until the all system install completely. Fix the camera after confirm the image and signal source are correct in last step. Please keep camera toward upside with triangle sign. (The triangle is on the side and back of camera)



3. Side Image:

Please install camera C0618N

3.1 Camera needs assembly with cover housing and mount in the bottom of side mirrors. Please keep camera toward upside with triangle sign. (The triangle is on the side and back of camera)

Cover Housing for side image

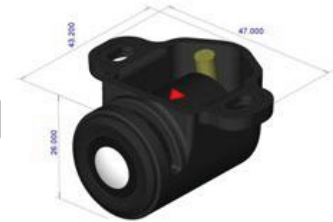

3.2 Take apart side mirrors, and find the place for mounting the housing. Mark the mounting holes on the bottom of side mirror, and drill 1 hole between 2 mounting holes for through camera harness. Fix the camera with sicker temporary. Lock the screws after the all system install completely and confirm the image and signal source are correct in last step. (If the camera connector is too big to through the hole, you might take out the cover from connector, through the hole with terminal only)

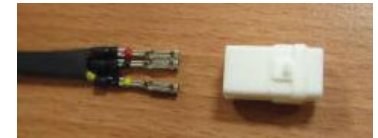

Install the Harness :

1.Harness of Backup Image

1.1 Remove the door trim through of left door and the cushion and back of backseat.

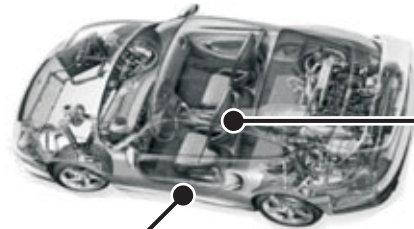

Remove the cushion and back of backseat

Remove the door trim through of left door



1.2 Heading the backup image related harness (Rear Trigger, CH1) through the direction of 1.1 to the rear camera.

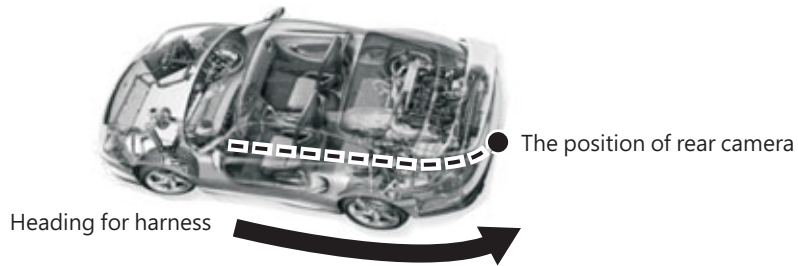

1.3 Connect the rear trigger with reversing light signal in the trunk.

2. Harness of Front Image

2.1 Remove the front skid plate or dashboard at the driver side. Deploy the harness (Left & Right Trigger, CH2&3) through the fire wall to the mounting holes in the front bumper.

2.2 Connect the left and right Trigger with left and right turn signals.



3. Harness of Side Image

- Unisee 300B, deploy the harness (Left & Right Trigger · CH2&3) through the skid plate under dashboard and glove box to both side mirrors. Connect the left and right trigger with left and right turn signals.
- Unisee 400A, only install the right side image. Deploy the harness (CH4) through the skid plate under glove box to right side mirror.
- Unisee400, deploy the harness (CH1&4) through the skid plate under dashboard and glove box to both side mirrors.



4. Harness of Monitor Image

Remove the A pillar cover. Deploy the V out harness through the skid plate under dashboard toward A pillar to LCD Monitor. With the mirror type monitor, extend the cable further to the roof panel. With the built-in monitor, follow the OE instruction to connect the video signal.

5. Harness of Power

Connect the Power harness to ACC of ignition switch.

6. Harness of GND

Attach the GND harness to vehicle steel body.

7. Switch

Determine the location where easy to operate for driver to mount the switch. Connect the SW harness to switch.

8. System control Box

Install the control box under the driver's seat or dashboard. Connect the harness connector with control box after determined the location where to mount the control box.

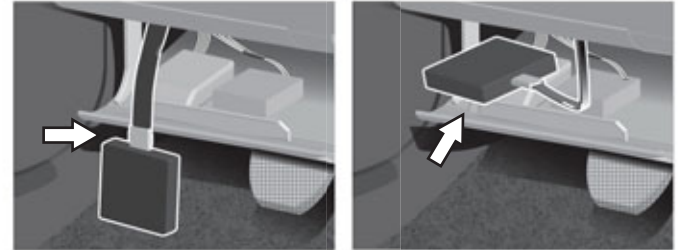

9. System Test

Start engine to ACC on, turn on the LCD monitor and press the switch. Check the image and view angle is normal from side cameras. Operate all trigger and check the system is normally.



10. Completed System Test. Fix all cameras and finish the system installation.

System Functions

- **Priority** Rear View > Switch Image > Left or Right Image
- **Principle**
 - Reverse trigger** : (Shows the rear view with assist line when shift into reverse gear) +12V output + monitor shows CH1
 - SW trigger** : Press the switch button and the monitor shows the left and right view with separate screen. After 1 min, it turns off automatically. (Or press it again to turn it off.)
 - Left / Right trigger** : The vehicle shows the left / right view when turning left / right.

After Installation

When all the trigger wires are connected correctly to the vehicle, the system will show the correct view on the screen as the driver turn left, right, reverse or press the switch.

Troubleshooting

Malfunction	Possible Cause	Solution
System is not on	Connector of the harness is not fully inserted into controller	Reconnect the harness
	Monitor is not correctly connected	Reconnect the monitor cable
	ACC or GND is not connected correctly	Reconnect the two wires. The contact of GND wire shall be free of dust and coating
	Fuse burning out	Replace the fuse
Image is not clear	Video cable is not connected properly	Reconnect the fault camera
	Camera is damaged	Replace the camera
	Lens is contaminated	Clean the lens
Image is not switched correctly	Left or right image is not displayed	Reconnect the left and right trigger
	Rear view is not displayed	Reconnect the rear trigger
	Corner view is not displayed	Check the connection of switch or replace the switch
Left and right split view is reversed	Monitor has been set as mirror view	Reset monitor to default
Left and right triggered to the other side	Wrong connect on the left / right trigger (left trigger connect to right turning light)	Request the technicians re-connect the wire
Image is not showed	Video cable is not connected	Reconnect it as the instruction
Triggered image shows very slow	Monitor delays itself to power on	Change a monitor or set the monitor to standby mode as default
No responses for all actions	Damaged by lightning, static electricity or other interference	Turn the engine off, and re-start it

● If the fault could not resolve by above ways, please let a professional technician repair or contact the local distributor. Please do no try to repair it on your own.

Specification

Operate Voltage	DC 9V-30V
Video System	720X486 (NTSC)
Video Input	11.0V p-p/75Ω×4
Video Output	Monitors (1.0V p-p/75Ω)×1
Trigger	4 triggers (SW & Reverse & Left & Right)
Assistant Parking Line	Yes (static)
Operate Temperature	Control Box -40°C ~ 70°C Camera -40°C ~ 85°C/ 105°C
Dimension of Control Box	107 mm (L) ×90 mm (W) ×30mm (H)
Power consumption	Standby about 2W Full loaded about 6W (full loaded: Camera x4 + LCD monitor x1 + control box x1)
Water Resistance Level	IP68 for all cameras

- Note: The specifications and appearance subject might be changed without prior notice.



UniSee™

For further information :



B E N E L U X
Spoorstraat 7 – U705
4702VV Roosendaal
Nederland

Info.rcbi@gmail.com

Tel NL : +31-(0)164-602928
Fax NL : +31-(0)164-602928
GSM NL : +31-(0)6-53618876
GSM B : +32-(0)495-518486